

USER GUIDE

**EC-pH
Transmitter**



EC/pH TRANSMITTER

TABLE OF CONTENTS

1	INTRODUCTION.....	- 3 -
1.1	MODULE OPTIONS	- 3 -
2	GETTING STARTED	- 4 -
2.1	MOUNTING THE WALL MOUNT	- 4 -
2.2	EC CALIBRATION	- 5 -
2.3	PH CALIBRATION.....	- 6 -
2.4	BOARD WIRING.....	- 7 -
3	MEASURING CHARACTERISTICS.....	- 8 -
3.1	EC MEASURING CHARACTERISTICS	- 8 -
3.2	PH MEASURING CHARACTERISTICS.....	- 8 -
4	HARDWARE SPECIFICATIONS.....	- 9 -
4.1	TRANSMITTER SPECIFICATIONS	- 9 -
4.2	SENSOR SPECIFICATIONS.....	- 9 -
4.3	POWER SPECIFICATIONS.....	- 10 -
5	TROUBLESHOOTING.....	- 11 -
5.1	EC TROUBLE SHOOTING.....	- 11 -
5.2	PH TROUBLESHOOTING.....	- 12 -
5.3	FACTORY SETTINGS.....	- 13 -
6	MAINTENANCE.....	- 14 -
7	ORDERING INFORMATION	- 15 -
8	WARRANTY	- 19 -
8.1	EC & PH TRANSMITTER	- 19 -
8.2	EC & PH SENSORS.....	- 19 -
9	CUSTOMER DECLARATION	- 20 -

EC/pH TRANSMITTER

1 INTRODUCTION

This product description relates to NETAJIM NetaJet, FertiKit and other dosing units.

This product description will guide you in the principles and operation of the EC/pH module along with maintenance and warranty information.

The EC/pH module consists of:

- a calculator/transmitter
- an EC and temperature probe
- a pH selective probe

The calculator/transmitter unit includes a 16 character LCD and Keyboard. The Keyboard is used to perform periodic calibration (sensors calibration is done using software). The LCD constantly displays the actual values of the EC and pH.

1.1 Module Options

The EC pH can be installed as a:

- wall mount (Figure 1) or
- panel mount (Figure 2)

The Panel Mount unit consists of one or two EC pH modules. All functionality is the same, irrespective of the number of modules. On the front panel of the Double Unit is a **SWAP** button, which the user presses to switch between modules.



Figure 1: Wall Mount Unit

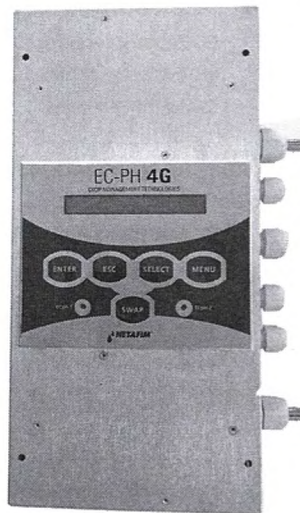

Figure 2: Single or Double Module Panel Mount Unit

EC/pH TRANSMITTER

2 GETTING STARTED

The following section details how to mount and calibrate your unit.

- Mounting the Wall Mount
- EC Calibration
- pH Calibration
- Board Wiring

2.1 Mounting the Wall Mount

1. Remove the mounting plates (x4) and screws (x8) from the plastic bag.

2. Fasten the mounting plates to the corners of the controller using four screws.

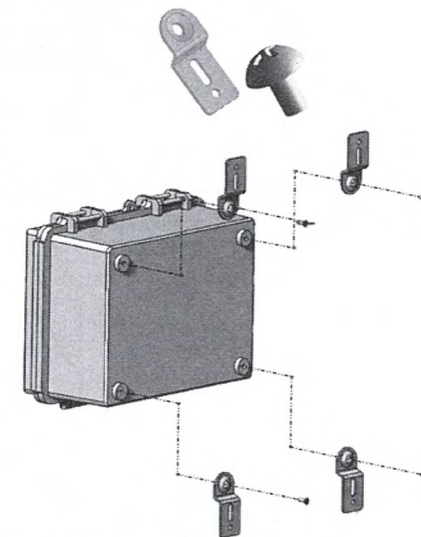

3. Place the controller box on the wall and make sure it is leveled (use a spirit level).
4. Using the remaining screws, secure the controller to the wall.

EC/pH TRANSMITTER

2.2 EC Calibration

Note: Perform the following procedure in one continual session. Interruptions or delays while performing the procedure can cause calibration failure.

1. On EC/pH screen press **MENU**.

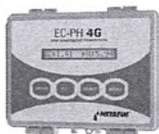

EC Calibration appears.

EC Calibration

2. Press **Enter**. Calib 1.4 appears.

Calib 1.4

3. Press **Enter**.

To EC 1.4 Enter

4. Clean and dry an EC sensor. Insert the sensor into 1.4mS calibration buffer; immerse for 5 – 7 seconds and immediately press **Enter**.



Calibration is in process.

EC: 1.4 Cal:1.4

Note: Perform the following step as soon as the EC 0 screen appears.

5. When the following screen appears, remove the sensor from the buffer and hold it in the air; press **Enter**.

To EC 0 - Enter

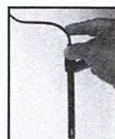

6. Calibration is in process; wait until next screen is displayed, which indicates that EC Calibration is complete.

EC: 0.0 Cal:0.0

7. Wait until the following screen appears.

Calibration OK

EC calibration is complete.

△ **NOTE:** If display says "BUFFER FAULT" please refer to Troubleshooting.

EC/pH TRANSMITTER

2.3 pH Calibration

Note: Perform the following procedure in **one continual session**. Interruptions or delays while performing the procedure can cause calibration failure.

1. On EC/pH screen, press **MENU**.



EC calibration appears.

EC Calibration

2. Press **Select** to scroll down to pH CALIBRATION.

pH Calibration

3. Press **Enter**.

To pH 7.0 Enter

Note: Perform the following step as soon as the EC 7.0 screen appears.

4. Verify that the pH sensor is dry; insert it into a pH 7 calibration buffer, immerse for 5 - 7 seconds and press **Enter**.



The following screen appears.

pH: 6.9 Cal:7.0

5. Calibration is in process, wait until the following screen appears.

To pH 4 - Enter

Note: Perform the following step immediately upon appearance of the pH 4 screen.

6. Verify that the pH sensor is dry; insert it into pH 4 calibration buffer, immerse for 5 - 7 seconds and press **Enter**.



The following screen appears.

pH: 3.3 Cal:4.0

7. Wait until the following screen appears.

Calibration OK

pH calibration is complete.

△ **NOTE:** If display says "BUFFER FAULT" please refer to Troubleshooting.

EC/pH TRANSMITTER

2.4 Board Wiring

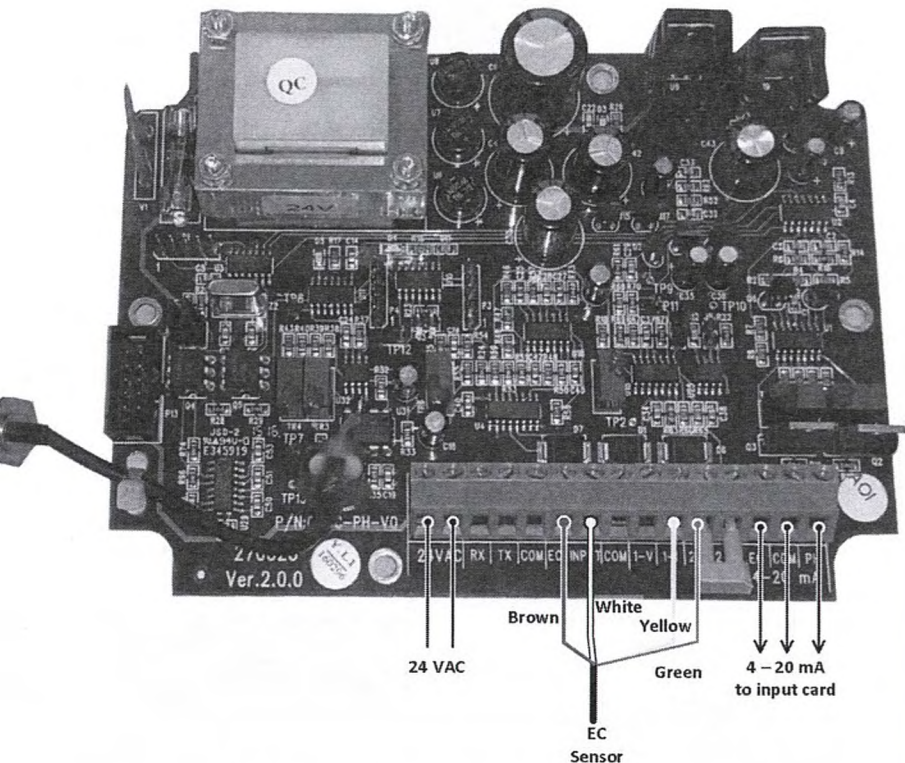

Figure 3: EC&pH Transmitter Wiring for EC Sensor (PT-100)

EC/pH TRANSMITTER

3 MEASURING CHARACTERISTICS

- EC Measuring Characteristics
- pH Measuring Characteristics

3.1 EC Measuring Characteristics

The electrical conductivity of water depends on the whole spectrum of the dissolved minerals in the water, and on the water temperature. Since our main interest is the nutrients concentration, a temperature sensor is included in the EC sensor to eliminate the temperature factor. The values of both conductivity and the thermistor are converted to digital data and reach as input to the unit's CPU, which calculates them to a curve. The accuracy of the calculation depends on the CPU's resolution. EC&pH utilized by 16 bit CPU which producing accurate reading even for values which are far from the calibration point.

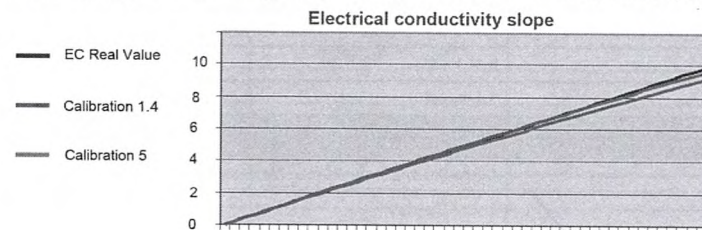

Figure 4: Water Value

The offset of the EC slope is always 0 (Zero). The EC sensor should indicate zero when it is wiped and held out in the open air. The second calibration point (gain) will be either EC 1.4 or EC 5 – whichever is closer to the final measured water.

3.2 pH Measuring Characteristics

The pH solution indicates the level of acid or alkali. The formal mathematical definition of pH is the negative logarithm of hydrogen ion activity. In most cases, hydrogen ion activity can be approximated by the hydrogen ion concentration, and the formula becomes $pH = -\log_{10} [H^+]$. On the pH scale, which varies from 0-14, a very acidic solution has a low pH value, a very basic solution has a high pH value, and a neutral solution has a pH of approximately 7.12.

A pH measurement loop is essentially a battery where the positive terminal is the measuring electrode and the negative terminal is the reference electrode. The measuring electrode, which is sensitive to the hydrogen ion, develops a potential (voltage) directly related to the hydrogen ion concentration of the solution. The reference electrode provides a stable potential against which the measuring electrode can be compared. When immersed in the solution, the reference electrode potential does not change with the changing hydrogen ion concentration. A solution in the reference electrode also makes contact with the sample solution and the measuring electrode through a junction, completing the circuit.

The electrode's output ranges is from $-417mV$ (pH 14) to $+417 mV$ (pH 0).

The quality of the measurement depends on the stability of the referenced electrode.

EC/pH TRANSMITTER

4 HARDWARE SPECIFICATIONS

- Transmitter Specifications
- Sensor Specification
- Power Specifications

4.1 Transmitter Specifications

Transmitter card	Data
Operating temperature	0 – 50°C / 32– 122°F
EC Input	Data (pt100)
EC Range	0 – 10 mS
Cell constant	K = 1 ±5%
Response time	1 second
EC Output	Data
4 – 20 mA	4mA=0mS, 20mA=10mS, Max load=200Ω
Monitoring	Local Display
Accuracy	0.05 to 0.1mS, including galvanic isolation
pH Input	Data
ION Selective	±417mV, 0mV=pH7.0
pH range	0 - 14
Response time	3 seconds for 98%
pH Output	Data
4 – 20 mA	5.6mA=1pH, 20mA=14pH, Max load 200Ω
Monitoring	Local Display
Accuracy	0.05pH
Max load impedance	500Ω

4.2 Sensor Specifications

pH Sensor	Data
Shaft material	PPO (polyphenylene oxide)
Diaphragm	Annular gap
Conductive system	Plastic cartridge
Pressure range	0 to 6 bar
Fitting length	120 mm

EC/pH TRANSMITTER

pH Sensor	Data
Electrode head	<ul style="list-style-type: none"> • plug cap (S6) • plug cap with fixed cable • screw cap Pg13.5 (S8) • screw cap Pg13.5 with fixed cable
Active pH element	UW glass (pH 0 — 12, briefly pH 14)
Active redox element	platinum tip (±2000 mV)
Electrolyte	solid electrolyte
EC Sensor	Data (pt100)
Cell constant1	K=1.0
Typical measuring range	0.1 to approx. 5 mS/cm
Temperature compensation	PT100
Process connection	Pg13.5 screw-in thread
Electrode material	Special graphite
Body material	PPO (polyphenylene oxide)
Maximum pressure	6 bar (at 25°C)
Electrical connection	Attached cable (free cable ends) or M12 connector

¹ Depending on the production conditions, the cell constant can deviate by ±10% from the nominal value.

4.3 Power Specifications Single Units

Parameter	Definition
Input current	<ul style="list-style-type: none"> • EC PH-4G-74340-003580 24 VAC ± 15%, 50/60 Hz, 5 Watts, 200 m A • EC PH-4G-74340-003581 24 VAC ± 15%, 50/60 Hz, 5 Watts, 200 m A
Fuse	315 mA

4.4 Power Specifications Double Panel Mount

Parameter	Definition
Input current	<ul style="list-style-type: none"> • EC PH-4G-74340-003582 24 VAC ± 15%, 50/60 Hz, 7 Watts, 550 mA
Fuse	315 mA

⚠ **Note:** Ensure that the EC-PH Wall mount is connected to an external, easy to reach, power disconnection device (for example switch, (labeled) circuit breaker, AC/AC adapter plug).

5 TROUBLESHOOTING

- EC Trouble shooting
- pH Troubleshooting
- Factory Settings

5.1 EC Trouble shooting

The EC soft calibration is define to correct the following deviations:

- EC 1.4: Correct a deviation of up to 0.7mS
- EC 5: Correct a deviation of up to 1mS

Any Higher deviation will presented as BUFFER FAULT.

Description	Course of action	Instructions
EC reading problem	Disconnect the EC sensor	Perform a Factory set and verify that EC is 0, otherwise, replace the card
Power problem	Check the supplied power while the unit is ON	The voltage range should be between 18 to 28VAC, if the power source proven normal – replace the card
EC calibration fail	EC electrode chemical treatment	1. Oil remains will be removed by hot water (70°) and detergent. 2. Immerse the probe in Sodium dioxide 2-3% for 2 minutes. Wash with fresh water. Perform Autose, and then regular calibration.
EC calibration fail	Transmitter card check	Use an Ampere-meter in order to compare the 4-20mA transmitted value the EC value that presented on the display. EC 1.4 should transmit 6.24mA, EC 5 should transmit 12mA
Significant deviation between the transmitted value and the reading	Replace card	

5.2 pH Troubleshooting

The pH sensor is very sensitive; make sure:

1. The pressure in the system never exceeds 6.0Bar / 85PSI
2. The sensor immersed in the water even when the system is in rest.
3. The water content/quality in the system is normal.

The pH soft calibration define to correct a deviation of up to 1.0 pH, therefore correction of pH 7.0 can be made when the value range is between 6.0 to 8.0.

Exceeding this range will presented as BUFFER FAULT.

Description	Course of action	Instructions
pH reading problem	Disconnect the pH sensor by the BNC connector	Short between the BNC poles on the transmitter side, perform an Factory set and verify that the pH value is 7.0
Power problem	Check the supplied power while the unit is ON	The voltage range should be between 18 to 28VAC, if the power source proven normal – replace the card
Liquid is poor	pH electrode chemical treatment	1. Oil remains will be removed by hot water (70°) and detergent. 2. Immerse the probe in Sodium dioxide 2-3% for 2 minutes. Wash with fresh water. Perform Autose, and then regular calibration.
Liquid is Poor	Transmitter card check	Use an Ampere-meter in order to compare the 4-20mA transmitted value the pH value that presented on the display. pH 7.0 should transmit 12mA, pH 4.0 should transmit 8.57mA
Significant deviation between the transmitted value and the reading	Replace card	

△ NOTE: Distinction between an old pH sensor to a new one made by noticing its content. The contents in a new probe is thick (gel state), whereas the contents of an old probe is thin (liquid state). When a probe nears its end, we recommend having a replacement probe ready, within easy access

EC/pH TRANSMITTER

EC/pH TRANSMITTER

5.3 Factory Settings

- EC Factory Set
- PH Factory Set

6 MAINTENANCE

The pH sensor requires periodic maintenance of cleaning and calibration. The duration between one periodic cleaning and calibration to the next depends on process conditions and the user's accuracy.

- The recommended period between calibrations of the pH sensor should not exceed four weeks.
- The EC sensor requires periodic maintenance too, but not as frequently as the pH sensor since it's not so sensitive.
- The recommended period between calibrations of the EC sensor should not exceed six months.

5.3.1 EC Factory Set

1. On EC/pH screen, press **MENU**.

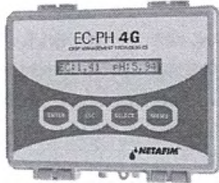

EC Calibration appears.

EC Calibration

2. Press **Select** and scroll down to EC FACTORY SET. Press **ENTER**.

EC Factory Set

3. Press **Enter**.

For EC Def-Enter

4. Press **Enter**.

Factory Set Ok

5. Go back to main screen by pressing **ENTER**.

5.3.2 PH Factory Set

1. On EC/pH screen, press **MENU**.

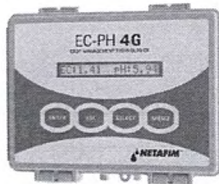

EC calibration appears.

EC Calibration

2. Press **Select** and scroll down to pH FACTORY SET.

pH Factory Set

3. Press **Enter**.

For pH Def-Enter

4. Press **Enter**.

Factory Set Ok



5. Press **Enter** to go back to the main screen.

Description	Period	Instructions
Primary cleaning of EC sensor	Every calibration	Slightly wipe with napkin
Primary cleaning of pH sensor	Every calibration	Direct stream of water on the sensor's membrane
Chemical treatment of EC sensor	Every six months OR when calibration process fails	1. Oil remains are removed by hot water (70°) and detergent.
Chemical treatment of pH sensor		2. Immerse the probe in Sodium dioxide 2-3% for two minutes. Wash with fresh water. Perform Autose, and then regular calibration.

EC/pH TRANSMITTER

EC/pH TRANSMITTER

7 ORDERING INFORMATION

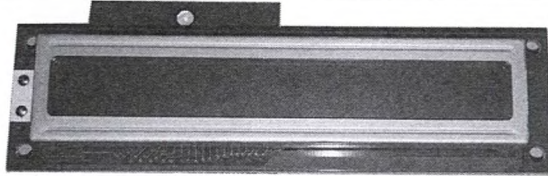

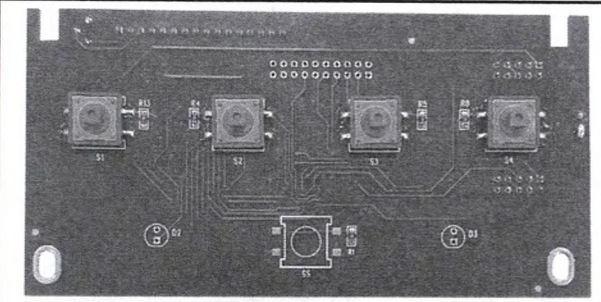
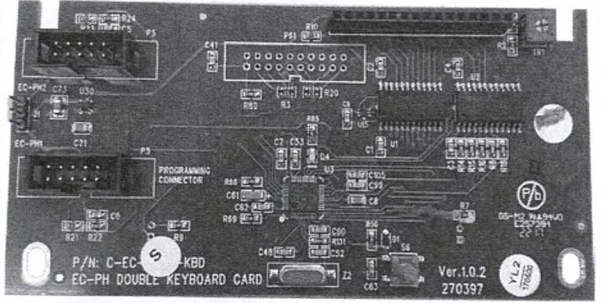
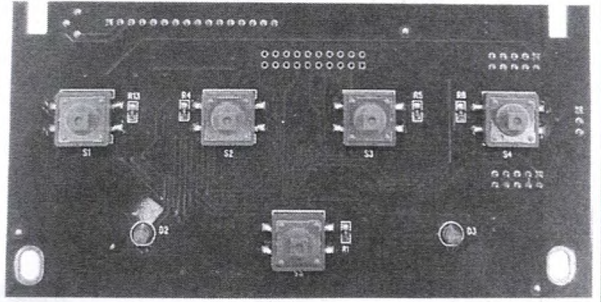
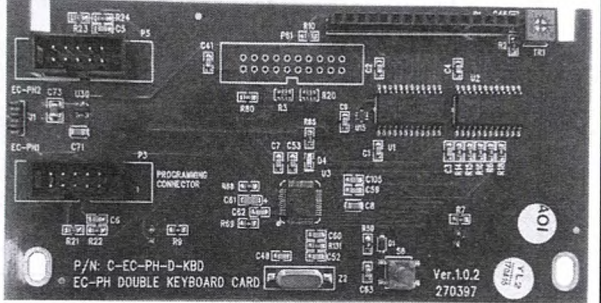

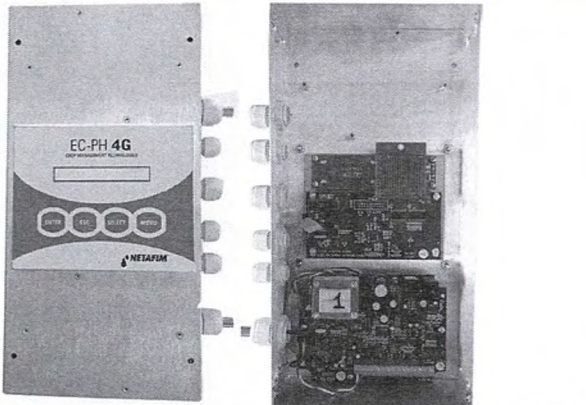
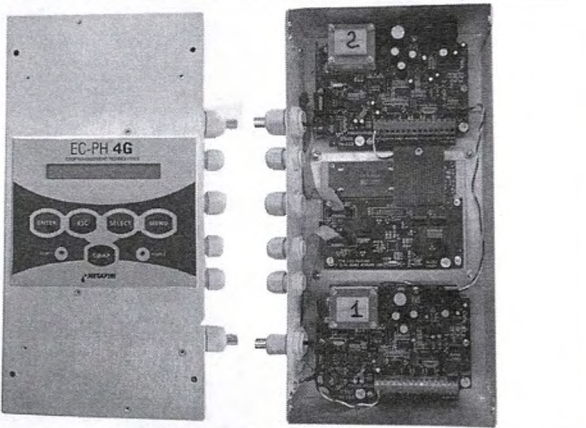
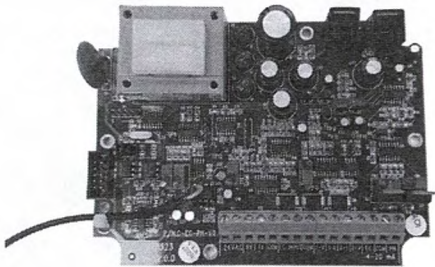

Catalog number	Description	Picture
33000-003315	EC&PH Set Wall Mount 24 Volt EC&pH Kit, includes: Transmitter Box, EC&pH Sensors and PVC adapters, calibration buffers (five each): pH7.0, pH4.0 and EC1.41	
74340-003580	EC pH - Monitor 24 Volt Wall Mount	
74340-022210	EC-PH LCD	

74340-003583	EC-PH-KBD Wall Mount 4 Buttons Keyboard Card	 
74340-023505	EC-PH Panel Mount 5 Buttons Keyboard Card	 

EC/pH TRANSMITTER

EC/pH TRANSMITTER

<p>74340-003581</p>	<p>EC pH Monitor 24 Volt Panel Mount</p>	
<p>74340-003582</p>	<p>Double EC pH Monitor 24 Volt Panel Mount</p>	
<p>74340-003584</p>	<p>EC-PH Card 24Volt</p>	

<p>45000-006692</p>	<p>pH Sensor Jumo 12MM Glass W/BNC Connect</p>	
<p>45000-006705</p>	<p>EC Sensor Jumo Temperat Comp.PT100 12MM</p>	
<p>45000-006440</p>	<p>20ml PH4.01 Buffer FOR pH Calibration</p>	
<p>45000-006460</p>	<p>20ml PH7.01 Buffer for pH Calibration</p>	
<p>45000-006480</p>	<p>20ml EC 1.41mS for EC Calibration</p>	
<p>82000-001010</p>	<p>Manual for EC&PH SET 24 Volt</p>	

EC/pH TRANSMITTER

8 WARRANTY

Netafim thanks you for buying EC&pH Unit and ensures you that it is taking great measures to provide high quality, tested products.

8.1 EC & pH Transmitter

Netafim guarantees the product's proper operation for a period of 12 months from date of installation.

If a defect is discovered during the applicable warranty period, Netafim will repair or replace, at its option, the product or the defective part.

△ Note: Lightning and surge damage is not covered by warranty

8.2 EC & pH Sensors

EC and pH sensors are considered perishable items. Netafim™ will warrant these items to be free of defects in material and workmanship for 3 months from the date of installation, provided the installation has been reported to Netafim™ within 30 days, or 6 months from date of production if installation was not reported or was reported later than 30 days from the date of installation.

△ Note: The pH sensor must be immersed in water at all times, protected from freezing and not exposed to pressures greater than 6Bar / 85PSI. Damage from these causes is not covered by warranty.

Date of installation must be confirmed and signed on by an authorized Netafim dealer (see details below).

The guarantee is limited to proper use of the system as instructed below:

- The system was installed by an authorized Netafim dealer.
- The system was used under normal conditions and was not abused or neglected.
- Netafim does not cover damage caused due to powers of nature, corrosion or in case the product fall.
- Netafim does not cover damage caused due to theft, hooliganism or other forms of abuse.

In case of damage covered by the warranty Netafim will repair or replace any product (or part of a product) as it sees fit.

EC/pH TRANSMITTER

9 CUSTOMER DECLARATION

I hereby confirm that the product has been delivered and commissioned to my satisfactory and that it is operating properly. I also confirm that the terms of the warranty are understood and agreed upon.

Date of commissioning: _____

Customer's representative:

Netafim's representative:

Name: _____

Name: _____

Signature: _____

Signature: _____

△ Caution: The product warranty will not apply if the defect is the result of accident, misuse, abuse, alteration, neglect, improper or unauthorized maintenance or repair, or if the product is used in any way that is in contradiction to the manufacturer's instructions.

Manufacturer's Address:

18 HaSivim Street
Petach-Tikva 49517, Israel